

E-STATIS *Advantage* 40 System

Operator's Manual



CAUTION: Federal law restricts this device to sale by or on the order of a dentist.

Table of Contents

1	Introduction	3	5	Operation.....	13
	Packing List.....	3		General Operation.....	13
2	Important Information	4		Mode - Interpretation	14
	Intended Use.....	4		Symbols.....	15
	Disposal	5		Settings: Preparation Mode P1 to P3:	17
	Service.....	5		Settings: Endodontic Mode E1 to E5.....	18
	Operating Mode	5		Settings: Set-up Menu	20
	Safety Precautions.....	6	6	Troubleshooting.....	22
	Applied Symbols	8	7	Information on Electromagnetic Compatibility.....	23
	Exclusion of Liability.....	8	8	Specifications	25
3	Cleaning and Maintenance.....	9		Control Unit	25
	Cleaning.....	9		Power Supply	25
	Maintenance	9		Media Supply Data	26
4	Installation and Commissioning.....	10		Recommended Settings	26
	Location	10		Ambient Conditions of Control Unit and Power Supply....	26
	Connection.....	10		Type label.....	26
	Connect Power Supply	10	9	Spare parts.....	27
	Connect Control Unit.....	11	10	Limited Warranty	28
	Connect Medical Device	11			
	Calibrate Foot Control.....	12			

E-STATIS is a registered trademark of SciCan Ltd. All other trademarks referred to in this manual are the property of their respective owners.

For all service and repair inquiries:

Canada: +1-800-870-7777
 United States: +1-800-572-1211
 International: +1-416-446-4500
 E-Mail: techservice.ca@scican.com

Manufactured by:

SciCan GmbH

Wangener Strasse 78
 88299 Leutkirch
 GERMANY

Phone: +49-7561-98343-0
 Fax: +49-7561-98343-699



SciCan Ltd.

1440 Don Mills Road,
 Toronto, ON M3B 3P9, CANADA
 Phone: +1-416-445-1600
 Fax: +1-416-445-2727
 Toll free: +1-800-667-7733

SciCan Medtech AG

Alpenstrasse 16,
 6300 Zug, SWITZERLAND
 Phone: +41-41-727-70-27
 Fax: +41-41-727-70-29

SciCan Inc.

701 Technology Drive,
 Canonsburg, PA 15317, USA
 Phone: +1-724-820-1600
 Fax: +1-724-820-1479

1 Introduction

Dear user,

We hope that you will enjoy using your new quality product. In order to ensure that you can work in a trouble-free, economical and safe manner, please comply with the instructions below.

Packing List

E-STATIS *Advantage* 40 System unit

E-STATIS *SLM* Motor

Operator's manual

Power supply 100 - 240 V AC

Power supply cord set

2 Important Information

! The operator's manual should be read by the user before starting up the unit for the first time in order to avoid incorrect operation or damage. Duplication and/or distribution of this operator's manual requires the manufacturer's prior consent.

All specifications, information and properties of the product described in this operator's manual correspond to the status upon going to press.

Modifications and improvements to the product as a result of new technical developments are possible.

This does not imply any right to retrofitting of existing units.

The manufacturer assumes no responsibility for damage arising through:

- External influences (poor quality of the media or faulty installation)
- Use of incorrect information
- Improper use
- Improperly performed repairs

Repair and maintenance work - apart from the activities described in this operator's manual - may be performed only by qualified technical staff.

- In the event of modifications by third parties, existing medical device licences become null and void.
- Only use original parts and spare parts.

Intended Use

! This medical device is:

- Only intended for dental treatment. Any other type of use or alteration to the product is impermissible and can be hazardous. The medical device is intended for the following use: Removal of carious material, cavities and crown preparations, removal of fillings, processing of tooth and restoration surfaces and endodontic treatment.
- A medical device according to relevant national statutory regulations.

This medical product:

- Includes a low-voltage electric dental motor in accordance with ISO 11498 type 2
- Is not approved for use in areas with an increased risk of explosion. (It is not suitable to use the dental unit in an atmosphere of flammable mixtures – AP, APG.).

Definition (intended purpose)	Meaning
Main function	Dental treatment for preparation and endodontic
Use	For dental treatment of crowns and roots
Main functional specifications	Mains powered additional component for dentist's unit
Duration of use	Approx. 30 - 40 minutes with individual interruptions per day

Population: all patients (all age-groups)

According to these provisions, the medical device is only to be used by an experienced user for the described application in accordance with:

2 Important Information

- The applicable health and safety regulations
- The applicable accident prevention regulations
- The operator's manual

According to these regulations, the user is required to:

- Only use equipment which is free of faults and works properly
- Only use the equipment for the proper purpose
- Protect himself, the patient and third parties from danger
- Avoid contamination from the product

Improper handling of hand-pieces:

Incorrect handling can result in injury to persons

- Follow the separate user instructions for the attachments.

Target group:

This document is for dentists and office personnel.

Disposal

Consumables:

The wastes incurred are to be recycled or disposed of in a way that is harmless for human beings and the environment; in doing so, the national valid regulations are to be observed.

Disposal of equipment and accessories at the end of their service lives:

On the basis of EC Directive 2002/96/EC on Waste Electrical and Electronic Equipment, we would like to point out that this product is currently in compliance with the labelling requirements but is not yet subject to the disposal requirements of this Directive. However, the unit may be disposed of in Europe in special waste management centres. Additional information can be obtained from the manufacturer or your dental supplier.

Service

Note:

Send the product every 2 years for a service check.

The safety check (STK) according to VDE 0751-1 and the measurement check (MTK) will be carried out during service check.

The safety checks in different countries can vary in compliance with country specific regulations and requirements for medical devices. The national valid regulations are to be observed.

Operating Mode

Note:

30 seconds operating time and 9 minutes interval is the feasible limit load of the motor (full load at maximum speed).

2 Important Information

In practice, it is realistic for impulse loading to last a number of seconds and intervals to last anywhere between a number of seconds to a number of minutes, with the maximum motor current not usually being reached. This represents the typical procedure for dentists.

Safety Precautions

Risks from electromagnetic fields (pacemakers):

The functions of implanted systems (such as pacemakers) can be influenced by electromagnetic fields.

- Ask patients before starting treatment and inform them about the risks.

Electricity:

Electrical shock caused by incorrectly connecting third-party system to the medical device.

- When installing and operating the medical device with treatment equipment and devices from other manufacturers, observe the provisions in "Protection against electrical shock," "Leakage current," and "Non-grounding the application part" in accordance with IEC 60601-1.

Risk from the lack of control equipment:

Hazards can arise if control equipment is not available for changing the speed and the direction of rotation.

- The connected dental treatment unit must have control equipment for changing the speed and direction of rotation.
- In addition, the accompanying documents must refer to them due to responsibilities arising from safety, reliability and performance.

Premature wear and tear; malfunctions caused by improper care and maintenance:

Foreshortened product life:

- Perform proper care and maintenance operations on a regular basis.

Malfunctions from electromagnetic fields:

The product meets the applicable requirements regarding electromagnetic fields.

Given the complex interactions between equipment and cell phones, the product may be influenced by a cell phone that is in use.

- Do not use cell phones in medical offices, hospitals, or laboratories.
- Turn off electronic devices such as computer storage media, hearing aids, etc. during operation .

Damaged cord / brittle cord / no ground wire:

Electric shock

- Inspect the cord before use.

Instrument tubing damage as a result of adhesive labels:

The instrument tubing may break

- Do not attach adhesive labels or tape to the tubing.

2 Important Information

The use of unauthorised file systems:

Unauthorised file systems can result in damage to the product and injury to persons.

- Only use authorised Ni-Ti file systems with a consistency >2%, suitable for rotary systems.
- Only use files with shafts meeting the requirements of ISO 1797-1, ISO 1797-2 and ISO 3630-1 and ISO 3630-2 norms, with a shaft diameter of 2.334 to 2.350 mm (0.092 to 0.093 inch).
- Please pay attention to the information provided by the manufacturer (method of operation, speed, torque stages, torsion consistency etc.) and appropriate use of the files.

The use of damaged files:

Damaged files can result in damage to the product and injury to persons.

- Before each root canal preparation, a rubber dam must be put in place for safety reasons.
- Each time before use, the files must be checked for possible signs of material fatigue, deformation or overstress and must be replaced if such signs are present..

Endangering of the practitioner and the patient:

Stop using the device immediately in the event of damage, irregular running noises, excessive vibrations, unusual generation of heat or if the drill bit is not firmly gripped.

Torque too high:

Damage of the attachment.

- Attachment for root canal treatments should only be used in the Endodontic mode.

Note:

Together with the dental treatment device, this medical device meets the requirements of IEC 60601-1-2. Only trained personnel are authorised by the manufacturer to repair and maintain the medical device.

Any claim under warranty shall be excluded if defects or the consequences thereof are due to manipulation or modifications to the product by the customer or by any third parties not authorized by SciCan.

Product Variant



The E-STATIS *Advantage* 40 kit is an update of SciCan's E-STATIS 40 Kit.

All specifications of the E-STATIS *Advantage* 40 are identical to the E-STATIS 40, except the motor, which is smaller and lighter than the motor which is packaged in the E-STATIS 40 kit.











2 Important Information

Applied Symbols

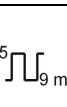







Appearing in the manual:

	A potential hazard to the operator.
	A situation that may lead to a mechanical failure.
	Important Information

Appearing on the unit:

	Sterilizable up to 135 °C (275 °F)		Manufacturer
	Type B applied part		Manufacturer in acc. EC Directive
	Operation mode: Duty cycle. The operation time is 0.5 minutes with a 9 minutes interval.		CE label
	Hint: Follow operator's manual		VDE test mark
	Disposal information see important information "Disposal"		CSA/UL test mark

Appearing on the packaging:

	Fragile		Stacking restrictions		Humidity
	Keep dry		Temperature range		Quantity
	Transport upright with the arrows pointing upwards.		Air pressure		

Exclusion of Liability

Supply of spare parts, service and maintenance may only be carried out by authorized personnel. SciCan shall assume no liability for accidental, special or consequential damage caused by maintenance or service of the E-STAT/IS unit by third parties, or for use of equipment or parts manufactured by third parties, including loss of profit, any commercial loss, economic loss or loss incurred by personal injury.

Never remove the cover of the device and never insert objects through the holes or openings on the case. Non-compliance may cause damage to the device and/or may endanger the user.

3 Cleaning and Maintenance

Cleaning

Disinfect the motor by wiping after each treatment.

The motor MUST be cleaned and CAN BE sterilized.

Use only disinfectants approved within the market of use.

Disinfect with a clean, damp cloth using isopropyl alcohol – see illustration below.

- Do not exert any pressure on the LCD screen.
- Do not use products containing acetone, chlorine or bleach as disinfecting agents.
- Never immerse in solvent.
- Not suitable for cleaning in an ultrasonic bath.

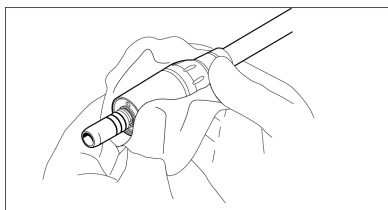

Maintenance

ATTENTION!



Repair and maintenance work on the electrical part of the *E-STATIS Advantage* must be performed only by specialists or by persons trained in the factory and familiarized with the safety regulations.

DO NOT OPEN CONTROL BOX. There are no serviceable parts inside the control box.

4 Installation and Commissioning

Operate the medical device exclusively with dental motor SciCan type E-STATIS SLM and Power supply type AMM120PS36.

! Location

Product installation can be on top, bottom or side of the dental unit in an accessible location.

Connection

Damage as a result of incorrect pressures.

Motor or instrument defects..

- Configure pressures in accordance with technical data!

Damage as a result of poor quality media.

Defect of motor or attachment.

- ISO 7494-2 states that compressed air must be clean, dry and free from oil.

! Note:

If necessary, insert a filter, water trap or air dryer.

Air requirements - see also: chapter 8 Specifications, page 25.

Measure cooling air quantity at motor coupling

see also: chapter 4 Installation and Commissioning "Measure cooling air quantity at motor coupling", page 11.

Connect Power Supply

! Note:

The power supply must be connected in compliance with country specific regulations and requirements for medical devices.

- Connect the power supply to the back of the unit.
- When switching off the dental unit, the plug of the power supply cord has to be disconnected from the mains.

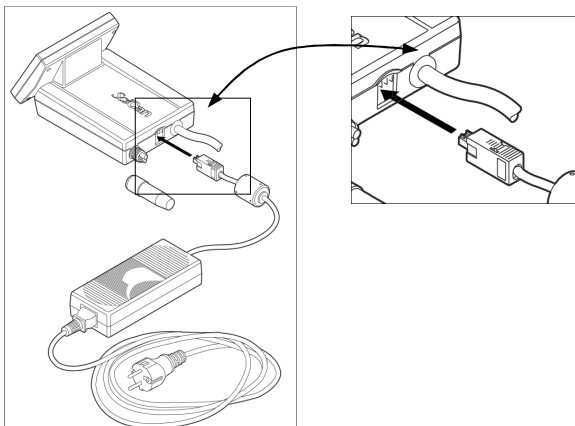

4 Installation and Commissioning

Connect Control Unit

- Connect the 4-hole, 5-hole or 6-hole tubing to the control unit four-hole connection.

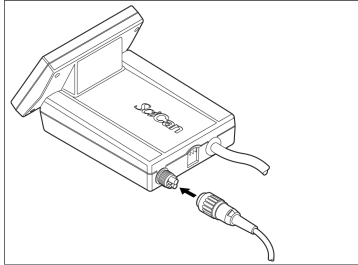

Connect Medical Device

- Connect the motor device with the motor tube.

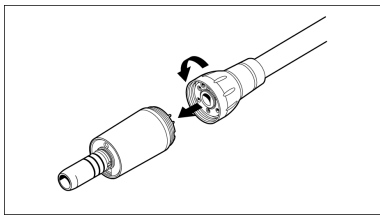

Measure the cooling air quantity of the motor coupling

When the motor is operating, the value must be around 7 – 10 NI/min (sphere upper edge).

- Attach a commercially available air quantity measurement tube motor.

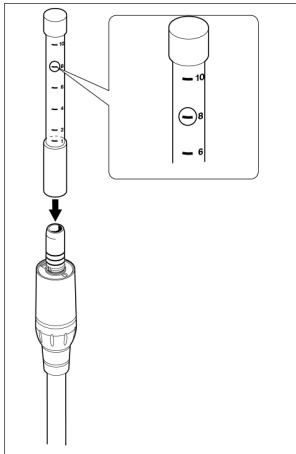

4 Installation and Commissioning

Calibrate Foot Control

Press "Set up" key.
The display then goes in to set up mode.

Pressing the button starts the "psi/bar" calibration process.



Proceed as follows:

1. If "MAX" is not already displayed on the "PSI/BAR" button, press "PSI/BAR" once or twice until "MAX" appears displayed on the "PSI/BAR" button.
2. When "MAX" is displayed the unit is ready to activate calibrating the maximum pressure.
3. Press the foot control **ALL THE WAY DOWN** and keep holding it down. Press and HOLD "PSI/BAR" button, (while "MAX" is displayed and foot control is being held all the way down), until signal sounds. Maximum pressure has now been calibrated (to equal 100%).
4. The "PSI/BAR" button should now have "MIN" displayed on it. If it does not, then press "PSI/BAR" once or twice until "MIN" appears displayed on the "PSI/BAR" button
5. When "MIN" is displayed the unit is ready to activate calibrating the minimal pressure.
6. **DO NOT PRESS THE FOOT CONTROL AT ALL**, and Press and HOLD "PSI/BAR" button, (while "MIN" is displayed), until signal sounds. Minimum pressure has now been calibrated (to equal 0%).

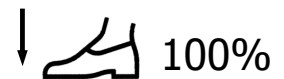

Calibration is finished.

5 Operation

General Operation

Parameters configured incorrectly

Damage as a result of incorrect input values.

- Check all input values before use. In preparation mode, the motor speed or drill speeds are displayed according to the speed increase or reduction ratio. In Endodontic mode, the drill speed, torque and drill direction are shown on the display.

Gearbox ratio incorrect

Damage caused by as a result of incorrect speed/torque.

- Select the corresponding transfer factor from the menu and store.

Damage resulting from use of a non authorized transformer.

Damage of product.

- Only operate the medical device with the power supply supplied!

Infection Control

- After treatment of a patient, let spray air and spray water leak for at least 20 seconds.
- Because of stagnation, water- or air-conveying lines in treatment units must be flushed or blown through before initial operation and after standing times (weekend, public holiday, vacation, etc.).
- The sterilization of the medical device must be effected via the treatment unit in the preparation mode.

Switch on medical device

Switch on product by plugging into the electrical circuit. The front circuit board and controller software versions are displayed on screen for a few seconds. For example:

SciCan
E-STATIS[®] Advantage

(V xx) OK*
(V xx) **

- * software version display
- ** software version control box

The parameters set (e.g. speed) are then shown on the display.

Note:

Once the foot control has been calibrated, the product is ready for use.

- Calibrate foot control - see also: chapter 4 Installation and Commissioning "Calibrate foot control", page 12.

5 Operation

Start of the dental motor

Note:





The motor start pressure is 1 bar (14.5 psi).

The minimum operating pressure at 40,000 rpm is 1.8 bar (26 psi).







- Press down the foot control pedal until the motor start pressure (1 bar, 14.5 psi) is exceeded. Motor started.
- Press the foot control pedal fully down. The configured speed is reached.

Mode - Interpretation

Preparation Mode

P1	200000		
P2	RPM 		
P3			1:5
E1	E2	E3	E4 E5

Endodontic Mode

P1	400		
P2	RPM 		
P3	0.4 Ncm 		4:1
E1	E2	E3	E4 E5





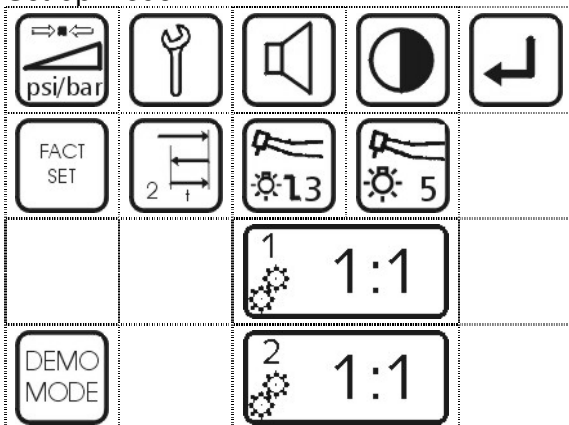

5 Operation

Set-up Mode











Symbols



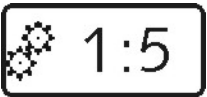
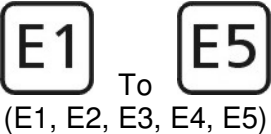
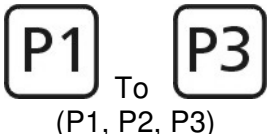
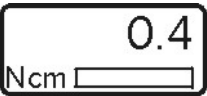

The following menu options can be called up:

Button	Function	Mode
	Set-up Mode for Submenu Entry and exit	Main menu and Set-up menu
	Instrument light on/off Submenu: illumination setting	Main menu and Set-up menu
	Submenu: illumination setting – delay time	Submenu in the set-up
	Calibration of foot control/working pressure	Submenu in the set-up
	Speaker on / off (Audio)	Submenu in the set-up
	Display contrast setting	Submenu in the set-up
	Change parameter values	Submenu and main menu

5 Operation

Button	Function	Mode
	Change parameter values	Submenu and main menu
	Direction of rotation counter-clockwise	Main menu
	Direction of rotation clockwise with Auto-stop	Main menu 1E to 5E (Endodontic mode)
	Direction of rotation Auto-reverse	Main menu 1E to 5E (Endodontic mode)
	Direction of rotation Auto-reverse forward	Main menu 1E to 5E (Endodontic mode)
	Bur speed	Main menu E1 to E5 and P1 to P3
	Ratio setting of the low speed attachments	Main menu E1 to E5 and P1 to P3
	Memory cell for Endodontic Mode	Main menu
	Memory cell for preparation	Main menu
	Torque value setting	Main menu E1 to E5
	Demonstration of motor rotation without air connection	Set-up menu

5 Operation

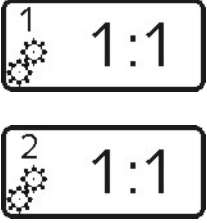
Button	Function	Mode
	Start Motor	Demonstration Mode
	Stop Motor	Demonstration Mode
	Service Menu -For Service Technician ONLY	Set-up menu
	Factory Settings	Set-up menu
	Additional Memory of reduction ratio for future hand-pieces with different ratios than currently available	Set-up menu

Settings: Preparation Mode P1 to P3:

Factory settings:

Key	Ratio -/ reduction rate	Speed	Light
P1	1 : 5	200,000 rpm	on
P2	1 : 1	40,000 rpm	on
P3	4 : 1	10,000 rpm	on

Possible settings:

Ratio -/ reduction rate

Direction of rotation (clockwise or counter-clockwise)

Light on/off

Speed selection at ratio 1:1	Speed selection at ratio 4:1
up to 1,000 rpm : in steps of 50	up to 100 rpm : in steps of 5
up to 2,000 rpm : in steps of 100	up to 1,000 rpm : in steps of 50
up to 10,000 rpm : in steps of 500	up to 2,000 rpm : in steps of 100
up to 40,000 rpm : in steps of 1,000	up to 10,000 rpm : in steps of 500

Menu P1, P2, P3

5 Operation

Press the P1, P2 or P3 button (when activated, the background colour changes to light grey)

Activate the gear ratio by pressing the "GEAR RATIO" symbol.  Select the appropriate increase or reduction ratio using the "+" or "-" symbol. Confirm the gear ratio by pressing the "GEAR RATIO" symbol again.

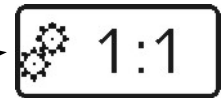

Activate the speed by pressing the "SPEED" symbol (when activated, the background colour changes to light grey). Change the speed using the "+" or "-" symbol until the speed you want appears in the display. Confirm by pressing the "SPEED" symbol again. The colour changes to black.

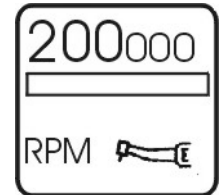

Select the fiber optic light by pressing the "LIGHT" symbol. If the symbol is black, the light is on; if the symbol is light grey, the light is off.

Select the direction of rotation by pressing the "DIRECTION OF ROTATION" symbol. If the symbol is white, the direction of rotation is clockwise; if the symbol is light grey, the direction of rotation is counter-clockwise.



Pressing the P1 button and holding it in until the signal sounds stores the options set in menu option P1.



Follow the same procedure for setting P2 and P3, if desired.

Settings: Endodontic Mode E1 to E5

Factory settings:

Key	Ratio -/ reduction rate	Speed	Torque	Direction of rotation	light
E1	4 : 1	400 rpm	0.4 Ncm	Auto-reverse	on
E2	4 : 1	400 rpm	0.4 Ncm	Auto-reverse	on
E3	4 : 1	400 rpm	0.4 Ncm	Auto-reverse	on
E4	4 : 1	400 rpm	0.4 Ncm	Auto-reverse	on
E5	4 : 1	400 rpm	0.4 Ncm	Auto-reverse	on

Possible settings:

Ratio -/ reduction rate

Direction of rotation (Auto-stop, Auto-reverse, Auto-reverse forward)

Torque limit Ncm

Speed selection

Light on/off

Menu E1, E2, E3, E4, E5

5 Operation



Note: The spray air and spray water must be switched OFF at the dentist element / foot switch.

Procedure with selecting E1 (Endodontic Mode):

Press the E1 button (when activated, the background colour changes to light grey). Activate the gear ratio by pressing the "GEAR RATIO" symbol. Select the appropriate increase or reduction ratio using the "+" or "-" symbol. Confirm the gear ratio by pressing the "GEAR RATIO" symbol again. Activate the speed by pressing the "SPEED/RPM" symbol (when activated, the background colour changes to light grey). Change the speed using the "+" or "-" symbol until the speed you want appears in the display. Confirm the speed by pressing the "SPEED/RPM" symbol again. The colour changes to black.

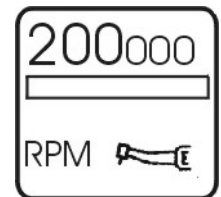
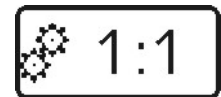

Select the torque by pressing the "TORQUE" symbol. The light grey symbol shows the active status. Select the appropriate torque value using the "+" or "-" symbol. Confirm by pressing the "TORQUE Ncm" symbol again.

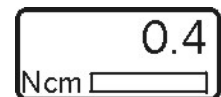

Select the fiber optic light by pressing the "LIGHT" symbol. If the symbol is black, the light is on; if the symbol is light grey, the light is off.



Select the direction of rotation by pressing the "DIRECTION OF ROTATION" button until the button for the desired direction is displayed. The choices will be:

Forward, Reverse, Auto-stop,



Auto-reverse,



or Auto-reverse forward



Note:

The torque value determines the point at which the direction of rotation will stop in Auto-stop; and the point at which the direction of rotation will reverse when in Auto-reverse and in Auto-reverse forward.

Confirm the direction of rotation by pressing and holding the "DIRECTION OF ROTATION" button.

Pressing the E1 button and holding it in until the signal sounds stores the options set in menu option E1.

Follow the same procedure for setting E2 through E5, if desired.



5 Operation

Settings: Set-up Menu

Press the "RETURN" button changes the display in set-up mode.



The following parameters can be set here:

Calibration (see: chapter 4 Installation and Commissioning "Calibrate foot control", page 12

	Setting options	Factory setting
Speaker	on / off	on
Illumination	1 – 10	5
Fiber Optic Delay	1 – 5 sec.	2
Display contrast	more / less	zero setting
Reverse time of Auto-reverse forward	1 – 5 sec.	2 sec.

Pressing the "SPEAKER" button changes the operating status of the speaker
If the symbol is white, the speaker is on; if the symbol is light grey,
the speaker is off.



By pressing the "ILLUMINATION" symbol, a number appears next to the symbol.
This number can be changed using "+" or "-". The number 1 equals the lowest light
output, the number 9 is the maximum light output. Confirm the illumination
setting by pressing the "ILLUMINATION" symbol again. The set and stored value
appears next to the symbol.



By pressing the "FIBER OPTIC DELAY" symbol, the delay time can be changed using
"+" or "-" to choose from 1 second to 5 seconds (delay time). Confirm the fiber optic
delay time by pressing the "FIBER OPTIC DELAY" symbol again. The set and stored
value appears next to the symbol.



By pressing the "AUTO-REVERSE FORWARD" symbol, a number with "t"
appears next to the symbol. The number can be changed using "+" or "-".
1 second to 5 second delay time for Auto-reverse forward. Confirm the delay
time set by pressing the "AUTO-REVERSE FORWARD" symbol again.
The set and stored value appears next to the symbol.

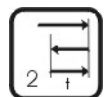

Pressing the "DISPLAY CONTRAST" button activates the symbol.
The display contrast can be changed using "+" or "-"
Confirm the contrast set by pressing the "DISPLAY CONTRAST" button again.



Select demo mode by pressing the "DEMO MODE" button.
The display changes to the 1E display.
The "START" button appears on the display.
Press "START" button – the motor starts running for 2 minutes max.



5 Operation

The running cycle of the motor can be interrupted by pressing "STOP" button.

By pressing the "RETURN" button the set-up menu appears and the demo program is finished.

Press the "RETURN" button, and the main menu appears.
Stand-by time setting of the touch screen.

All manual settings could be reactivated to the factory settings by pressing the "FACT SET" button.
Attention: All manual settings will be cancelled when this button is pressed.

Back to the main menu by pressing "RETURN" button.

Press one of the "Additional Memory" buttons (button number 1 or button number 2). With "+" or "-" select the desired transmission ratio.
Confirm the ratio by pressing the "ADDITIONAL MEMORY" button again



6 Troubleshooting

The medical device heats up and gets excessively hot when running without a load:

- Check the amount of cooling air.

The medical device has no lighting:

- Lighting control not activated - Check symbol on the control box.

Attached straight and contra angle is blocked (Error code "ERR 82"):

- Release blockage.

Motor or attachment defects:

- Incorrect pressure – Configure pressure in accordance with technical specifications.
- Poor quality air or water supply - check symbol on the control box.

Note:

If necessary, insert a filter, water trap or air dryer.

Air requirements - see also: chapter 8 Specifications, page 25

7 Information on Electromagnetic Compatibility

The medical device is suitable for use in the specified electromagnetic environment. The purchaser or user of the medical device should ensure that it is used in an electromagnetic environment as described below:

Emission Test	Compliance	Electromagnetic Environment
Radio-Frequency Emissions CISPR 11	Group 1	The medical device uses RF energy only for its internal function. Therefore, the RF emission is very low and not likely to cause any interference in nearby electronic equipment.
Radio-Frequency Emissions CISPR 11	Class B	The medical device is for use in all facilities including residential facilities and facilities that are directly connected to a public power supply that also supplies residential buildings.
Harmonic emissions IEC 61000-3-2	Class A	
Voltage fluctuations / flicker emissions IEC 61000-3-3	Complies	

Immunity tests	IEC 60601-test level	Conformance level	Electromagnetic environment - guidelines
Electrostatic discharge (ESD) IEC 61000-4-2	± 6 kV contact discharge ± 8 kV atmospheric discharge	± 6 kV contact discharge ± 8 kV atmospheric discharge	Floors should be made of wood or concrete or have ceramic tiles. When the floor is covered with synthetic material, the relative humidity must be at least 30%.
Fast transient electrical disturbances/ Bursts IEC 61000-4-4	± 2 kV for power lines ± 1 kV for signal lines	± 2 kV for power lines ± 1 kV for signal lines	The quality of the supply voltage should correspond to that of a typical business or hospital environment .
Surges IEC 61000-4-5	± 1 kV Push-pull voltage ± 2 kV common mode voltage	± 1 kV Push-pull voltage ± 2 kV common mode voltage	The quality of the supply voltage should correspond to that of a typical business or hospital environment .
Voltage interruptions, short-term interruptions and fluctuations of the supply voltage IEC 61000-4-11	<5% U_T for 0.5 periods 40% U_T for 5 periods 70% U_T for 25 periods <5% U_T for 250 periods	<5% U_T for 0.5 periods 40% U_T for 5 periods 70% U_T for 25 periods <5% U_T for 250 periods	The quality of the supply voltage should correspond to that of a typical business or hospital environment. When the user of the medical device needs continued operation even when the power supply is interrupted, it is recommended to supply the medical device from an uninterrupted power supply or a battery.
Magnetic field with a supply frequency (50/60 Hz) per IEC 61000-4-8	3 A/m	3 A/m	Power frequency magnetic fields should be at levels characteristic of a typical location in a typical commercial hospital.
Conducted HF disturbances IEC 61000-4-6	3 V_{eff} 150 kHz to 80 MHz outside of the ISM bands ^a	10 V_{eff}	<p>Portable and mobile radio devices should not be used closer to the medical device (including the electrical lines) than the recommended safe distance calculated using the equation for the transmission frequency. Recommended safe distance:</p> <p>$d = 0.5 \sqrt{P}$</p> <p>$d = 0.35 \sqrt{P}$ for 80 MHz to 800 MHz</p> <p>$d = 0.70 \sqrt{P}$ for 800 MHz to 2.5 GHz</p> <p>with P as the maximum rated power of the transmitter in Watts (W) according to the transmitter manufacturer, and d as the recommended safe distance in meters (m). ^bThe field strength of stationary radio transmitters should be less than the conformance level at all frequencies in an on-site check^c. ^dDisturbances are possible close to devices that have the following symbol.</p>
Radiated HF disturbances IEC 61000-4-3	3 V/m 80 MHz to 2.5 GHz	10 V/m	



7 Information on Electromagnetic Compatibility

NOTE: U_T is the alternating mains voltage before the test level is used.

NOTE 1: At 80 MHz and 800 MHz, the higher frequency range applies.

NOTE 2: These guidelines may not be applicable in every case. The spread of electromagnetic waves is absorbed and reflected by buildings, objects and people.

^a The ISM frequency bands (for industrial, scientific and medical applications) between 150 kHz and 80 MHz are 6.765 MHz to 6.795 MHz; 13.553 MHz to 13.567 MHz; 26.957 MHz to 27.283 MHz and 40.66 MHz to 40.70 MHz.

^b The conformance levels in the ISM frequency bands between 150 kHz and 80 MHz and the frequency range of 80 MHz and 2.5 GHz are intended to reduce the probability that mobile and portable communications equipment will produce disturbances when they are unintentionally brought near the patient. For this reason, the additional factor of 10/3 is used when calculating the recommended safe distances within these frequency ranges.

^c The field strength of stationary transmitters such as base stations of mobile telephones and land mobile radio devices, amateur radio stations, AM and FM, radio and television broadcasters cannot be theoretically predetermined. To determine the electromagnetic environment of stationary transmitters, a study of the location should be considered. When the measured field strength at the site where the medical device is used exceeds the above conformance level, the medical device should be monitored to demonstrate proper function. When unusual performance features are observed, additional measures may be necessary such as realigning or moving the medical device.

^d Within the frequency range of 150 kHz to 80 MHz, the field strength should be less than $3 V_{\text{eff}} \text{ V/m}$.

Recommended safe distance between portable and mobile HF telecommunications equipment and the medical device

The medical device is intended for use in an electromagnetic environment in which HF disturbances are controlled. The customer or the user of the medical device can help prevent electromagnetic disturbances by maintaining the minimum distance between portable and mobile HF telecommunications devices (transmitters) and the medical device depending on the output of the communication device as indicated below.

Rated power of the transmitter / W	Safe distance depending on the transmission frequency:		
	150 kHz to 80 MHz $d=0.35 \sqrt{P}$	80 MHz to 800 MHz $d=0.35 \sqrt{P}$	800 MHz to 2.5 GHz $d=0.70 \sqrt{P}$
0.01	0.04	0.04	0.07
0.1	0.11	0.11	0.22
1	0.35	0.35	0.70
10	1.11	1.11	2.21
100	3.50	3.50	7.00

For transmitters whose maximum rated power is not in the above table, the recommended safe distance d in meters (m) can be calculated using the equation for the respective gap, where P is the maximum rated power of the transmitter in Watts (W) according to the manufacturer's information.

NOTE 1: At 80 MHz and 800 MHz, the higher frequency range applies.

NOTE 2: These guidelines may not be applicable in every case. The spread of electromagnetic waves is absorbed and reflected by buildings, objects and people.

8 Specifications

Control Unit

Motor speed range (forward / reverse):	100 to 40,000 rpm (min ⁻¹)
Output torque:	max. 3.0 Ncm
Motor current:	max. 5.7 A / Phase
Motor voltage:	max. 22 V AC
Operation mode:	Duty cycle: 0.5 on / 9 off min
Current of LED	max. 250 mA
Air outlet of the coupling (cooling air):	7 to 10 NI/min
Spray air pressure:	1 to 2.5 bar (14.5 to 36.2psi)
Spray water pressure:	0.8 to 2.0 bar (11.6 to 29 psi)
Weight:	0.69 kg (1.521) kg (lbs)
Dimensions (Width/Height/Depth):	110 x 76 x 175 mm (4.33 x 2.99 x 6.89 inch)
Rotation:	clockwise / counter-clockwise
Sound level:	< 40 dBa
Instrument connection:	ISO 3964
Protection class:	Part of class I system
Overvoltage category:	II
Pollution degree:	P2
Device classification of applied part (EN 60601):	Type B
Protection category:	IP 20

Power Supply

Rated voltage:	100 to 240 V AC
Rated frequency:	50 / 60 Hz
Power consumption:	120 VA
Operation mode:	Duty cycle (0.5 on/9 off) min
Weight:	0.57 kg (1.26 lbs)
Dimensions (Width/Height/Depth):	73 x 41 x 175 mm (2.87 x 1.61 x 6.89 inch)
Protection class:	I
Overvoltage category:	II
Pollution degree:	P2
Protection category:	IP 40

8 Specifications

Media Supply Data

System pressure:	1.8 to 4.0 bar (26 to 58 psi)
Spray air:	1.0 to 2.5 bar (14.5 to 36.2 psi)
Spray water:	0.8 to 2.0 bar (11.6 to 29 psi)
Cooling air outlet on motor coupling:	7 to 10 NI/min
Air requirements:	Dry, free from oil, clean, uncontaminated according ISO 7494-2
Air filter:	50 µm
Water quality:	Tap water
ph-value:	7.2 to 7.8
Water filtration provided by customer:	80 µm

Recommended Settings

System pressure:	3.0 bar (43.5 psi)
Spray air:	1.0 bar (14.5 psi)
Spray water:	0.8 bar (11.6 psi)

Ambient Conditions of Control Unit and Power Supply

Location:	Permitted in interior rooms
Ambient temperature:	10 to 40 °C (50 to 104 °F)
Relative humidity:	30 to 75 %
Max. altitude:	2000 m

Storage and Transport Conditions of Control Unit and Power Supply

Danger when starting up the medical device after storage in very cold conditions.
This can cause an operational failure of the medical device.

Very cold devices must be brought to a temperature of 20 °C to 25 °C (68 °F to 77 °F) before being started up.

Ambient temperature:	-30 to 70 °C (-22 to 158 °F)
Relative humidity:	5 to 95 %
Air pressure:	700 to 1060 hPa
Keep dry!	

We reserve the right to make technical modifications.

Type label

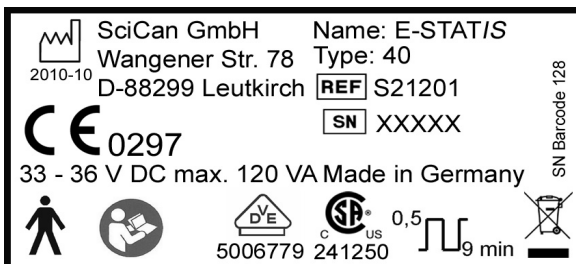

The explanations of the symbols are described in chapter 2 "Important Information".

9 Spare Parts

Spare Parts

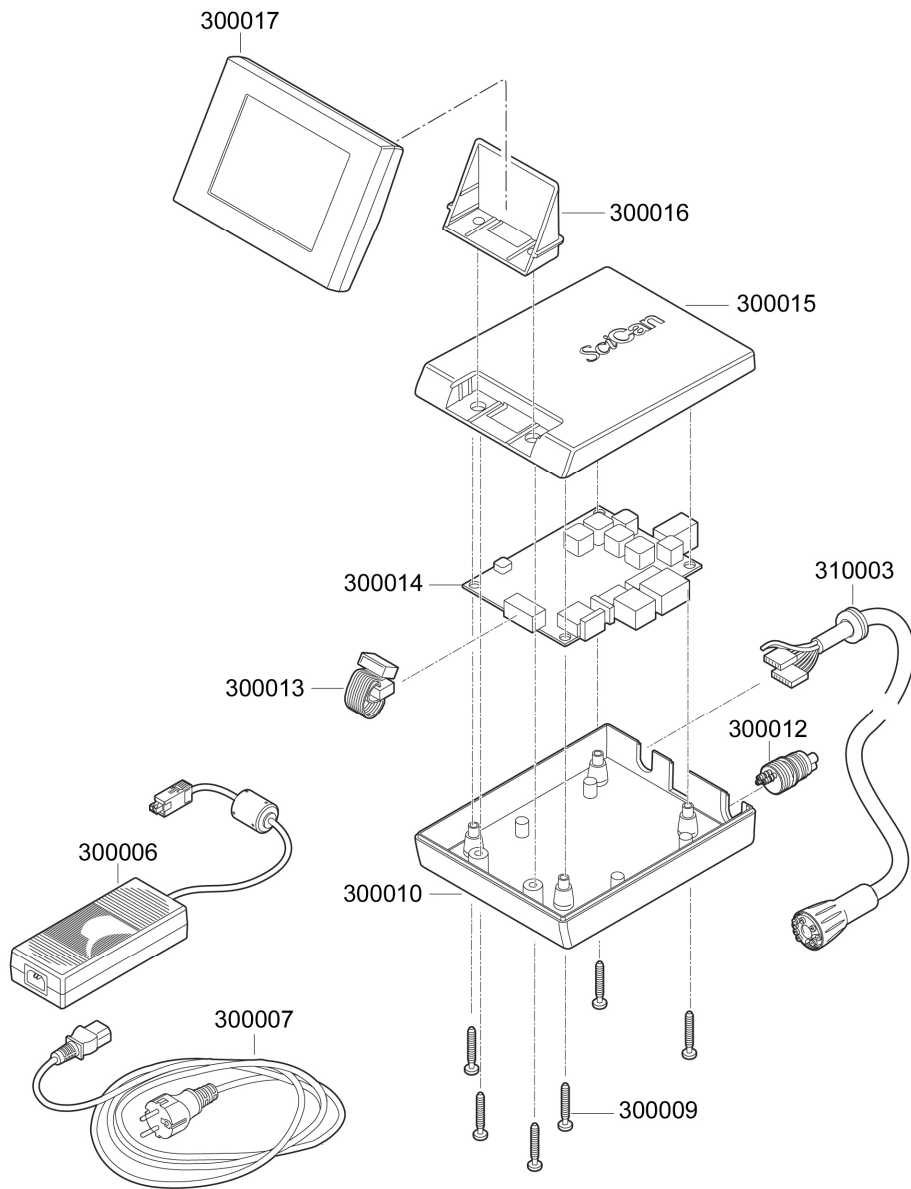

10 Limited Warranty

For a period of three years, **SciCan** guarantees that the **E-STATIS Advantage 40**, when manufactured by **SciCan** in new and unused condition, will not fail during normal service due to defects in material and workmanship that are not due to apparent abuse, misuse, or accident. The three years warranty will cover the performance of all components of the unit except consumables, provided that the product is being used and maintained according to the description in the operator's manual.

In the event of failure due to such defects during this period of time, the exclusive remedies shall be repair or replacement, at **SciCan's** option and without charge, of any defected part(s) (except gaskets, seals, O-rings and couplings), provided **SciCan** is notified in writing within thirty (30) days of the date of such a failure and further provided that the defective part(s) are returned to **SciCan** prepaid. This warranty shall be considered to be validated, if the product is accompanied by the original purchase invoice from the authorized **SciCan** dealer, and such invoice identifies the item by serial number and clearly states the date of purchase. No other validation is acceptable.

After three years, all **SciCan** warranties and other duties with respect to the quality of the product shall be conclusively presumed to have been satisfied. All liability, therefore, terminate, and no action or breach of any such warranty or duty may thereafter be commenced against **SciCan**.

Any express warranty not provided hereon and any implied warranty or representation as to performance, and any remedy for breach of contract which, but for this provision, might arise by implication, operation of law, custom of trade or course of dealing, including any implied warranty of merchantability or of fitness for particular purpose with respect to all and any products manufactured by **SciCan** is excluded and disclaimed by **SciCan**. If you would like to learn more about **SciCan** products and features, visit our website at www.scican.com.